

Solid State Start Switch (BACKEND)

General Electric Back-end Motors AMF 82-30 and 82-70

Westinghouse Back-end Motors AMF 82-30 and 82-70

Franklin, Smith etc Back-end and Ball Return Motors

**Dual Voltage 115/230V motor
 230V supply voltage**

Before

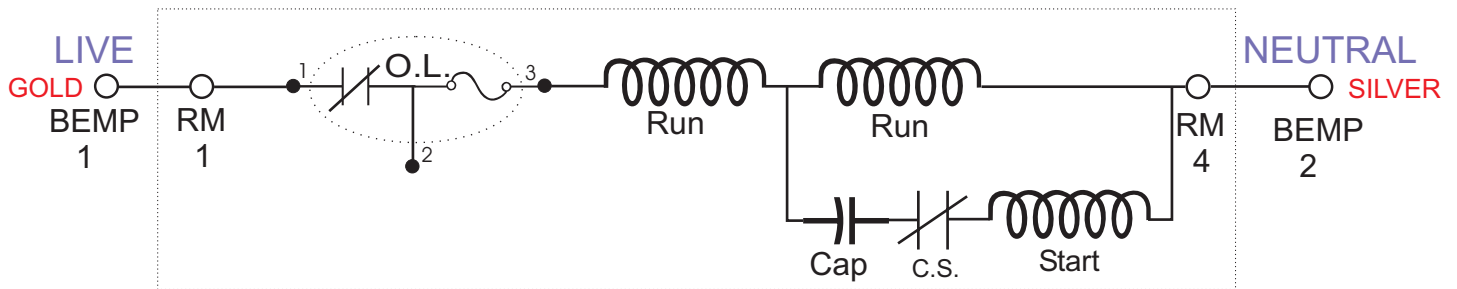

The RED and BLUE wires of the Solid State Start Switch take the place of the mechanical start switch.

The two BLACK wires supply 115V to power the switch.

The Solid State Start Switch senses the load on the motor by constantly measuring the current draw in order to determine when and for how long the START windings are required to be in-circuit.

After

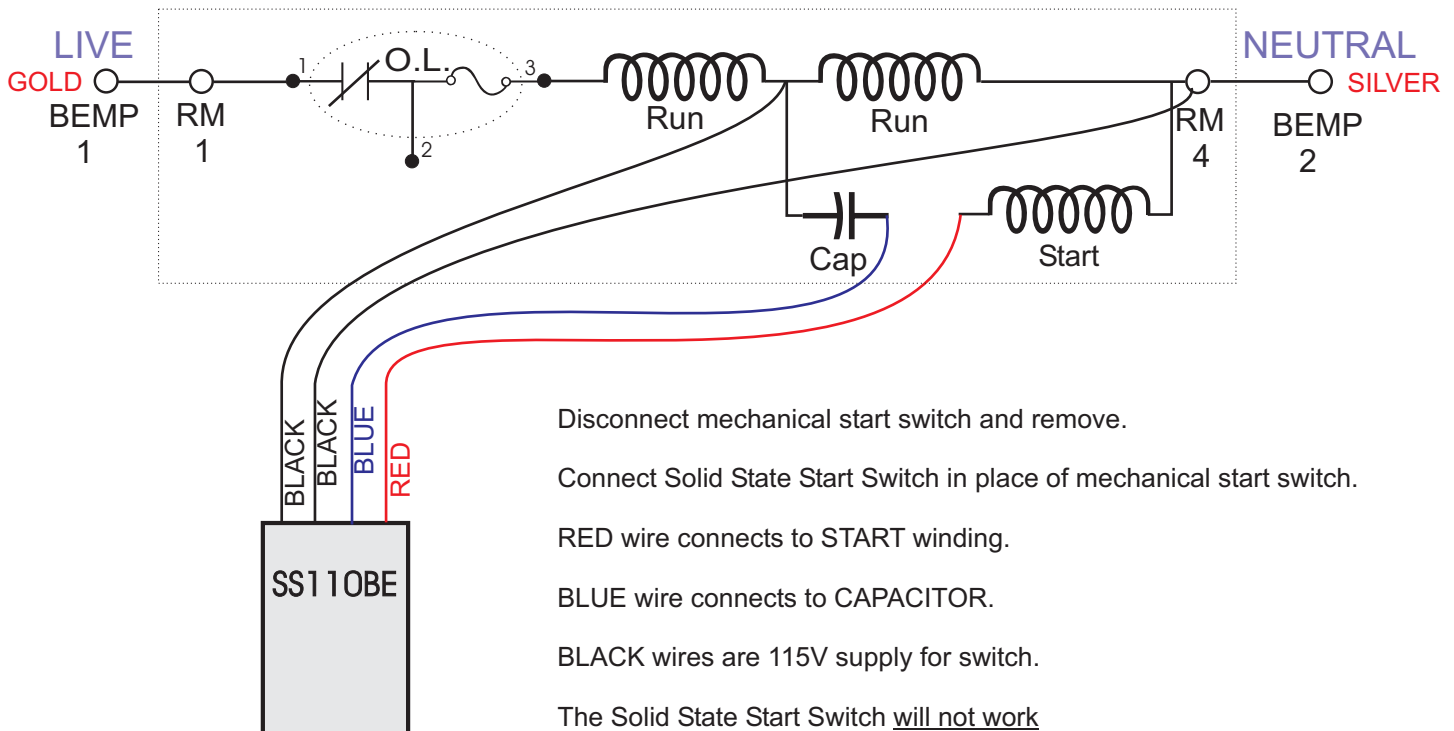

Disconnect mechanical start switch and remove.

Connect Solid State Start Switch in place of mechanical start switch.

RED wire connects to START winding.

BLUE wire connects to CAPACITOR.

BLACK wires are 115V supply for switch.

The Solid State Start Switch will not work if the RED and BLUE wires are reversed.